

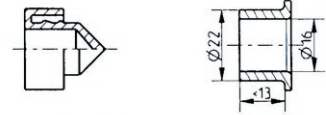

8mm Boiler Seals For Use With A Welded Boiler Stub

Part Number:

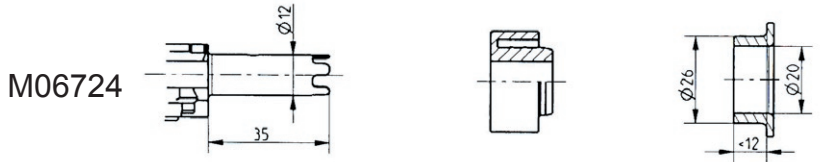
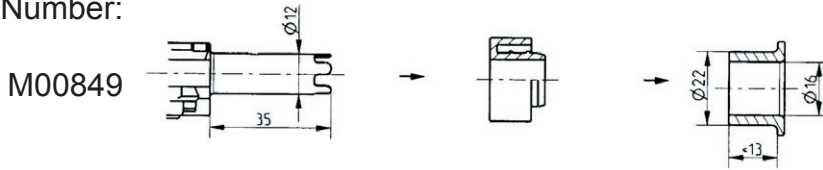

Blanking Seal

Part Number:

M05204

8mm Boiler Seals For Use With A Punched Boiler Hole

Punched Hole Dimensions:

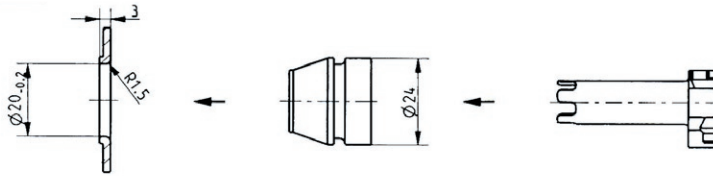

Part Number:

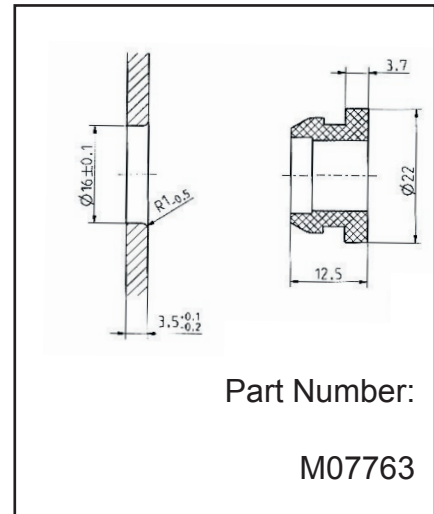
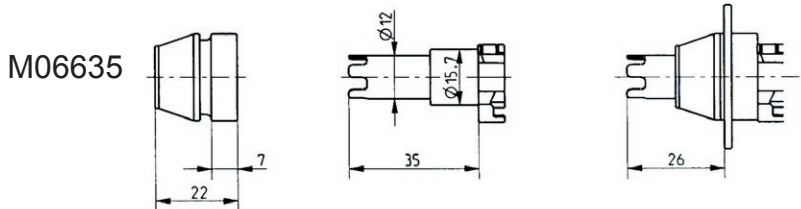
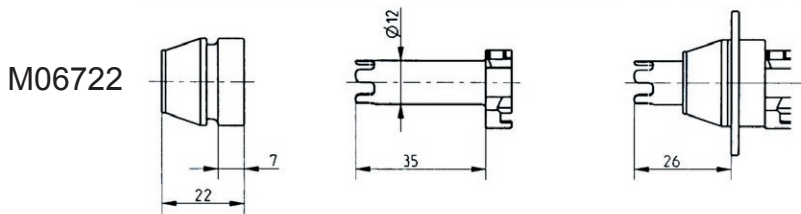

Part Number:

M07763

Blanking Seal

M06779

